

# MORELAND

3 BR  
1990 sq ft

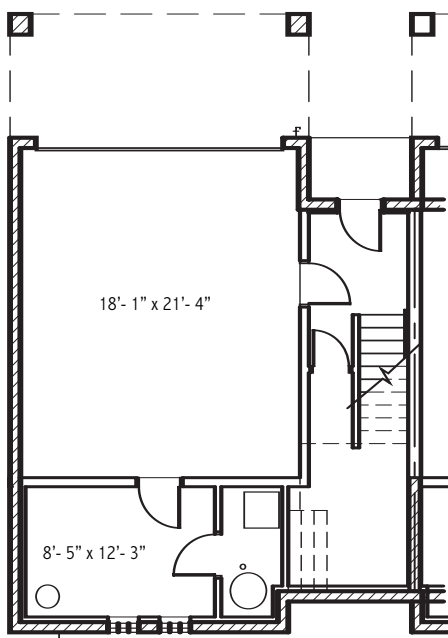

GARAGE

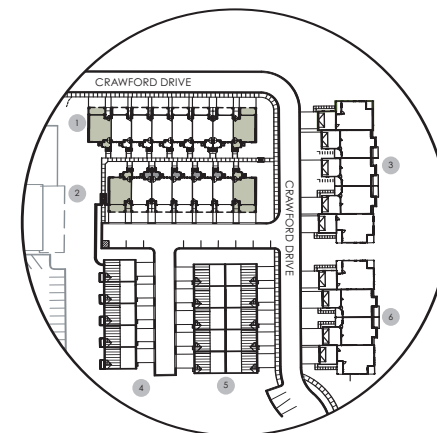
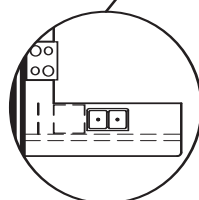

Optional  
Breakfast Bar

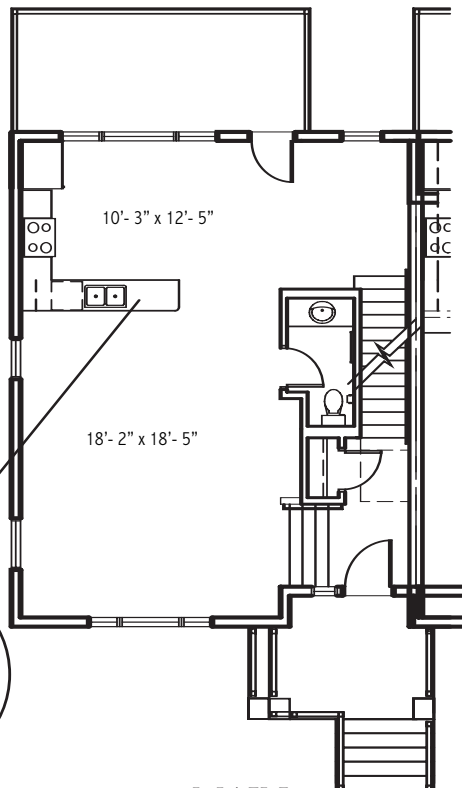

MAIN

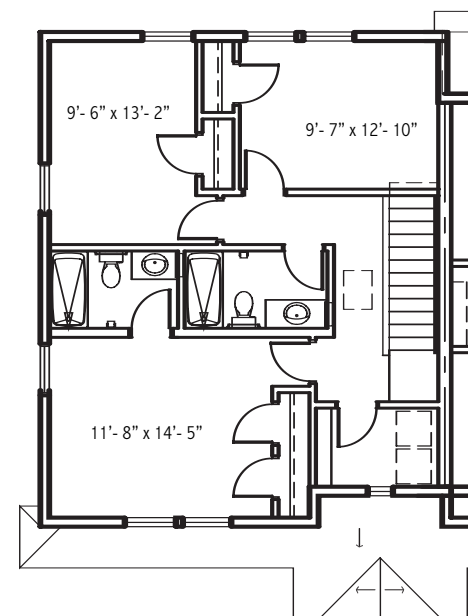

UPPER



# MORELAND

2 BR  
1609 sq ft

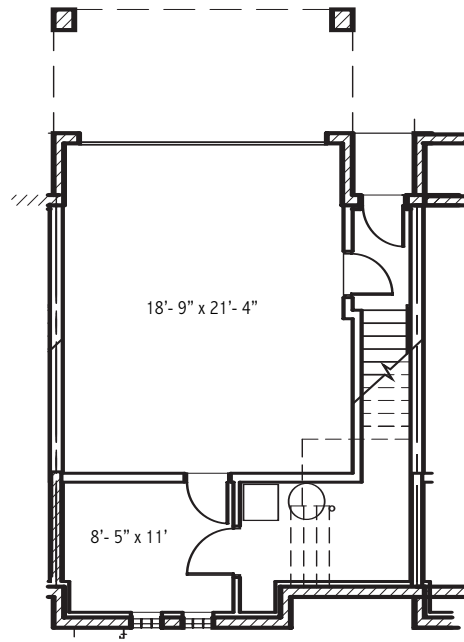
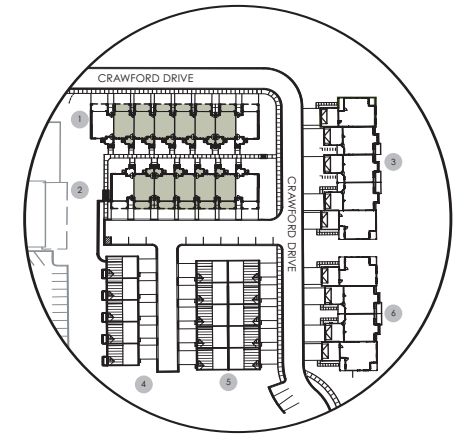

GARAGE

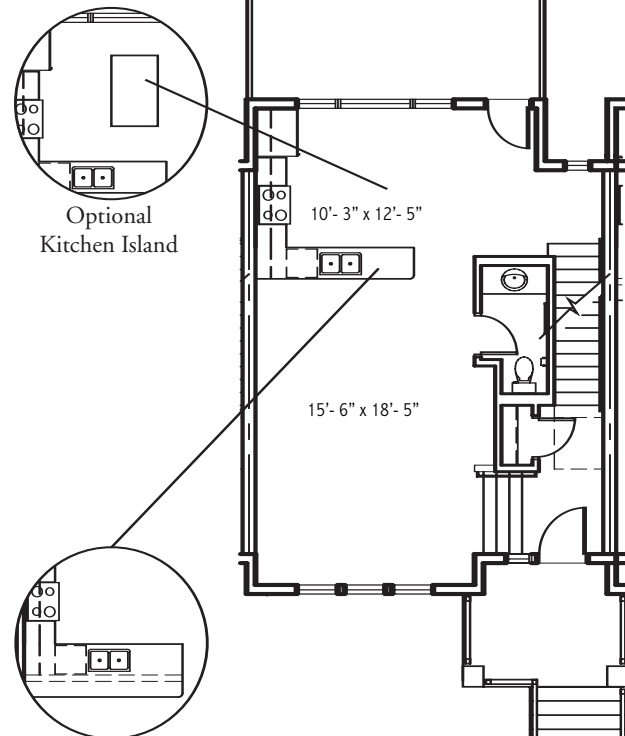

MAIN

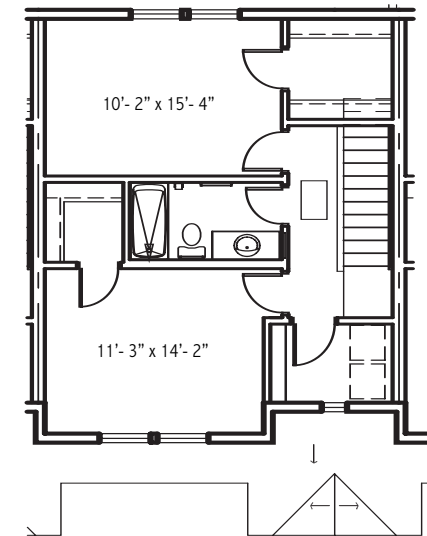

UPPER



# EMERSON

2 BR + LOFT

1518 sq ft

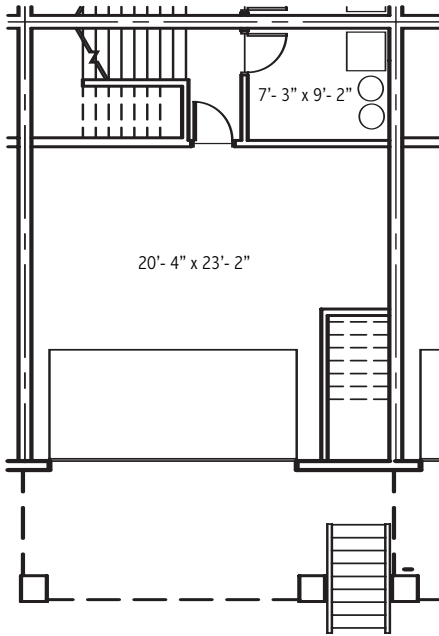
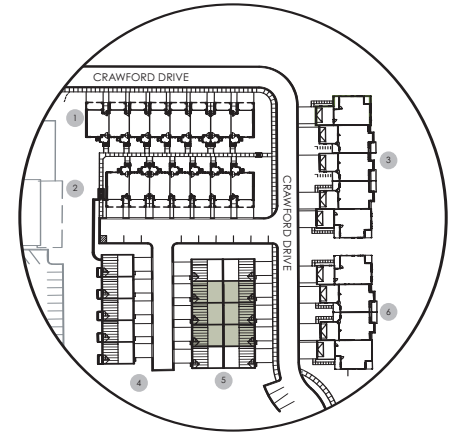

GARAGE

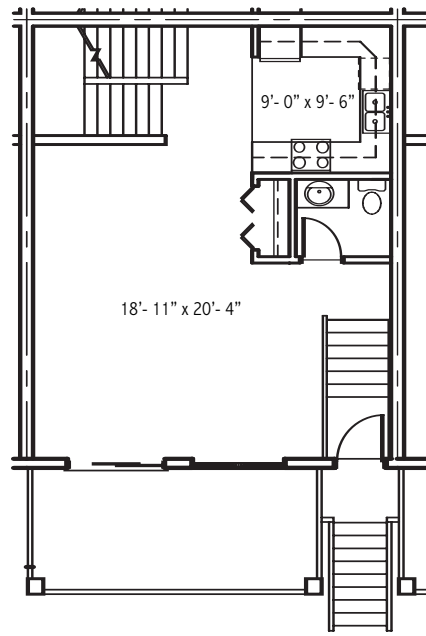

MAIN

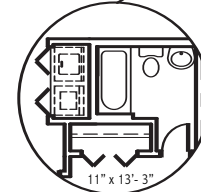

Optional  
Master Bath

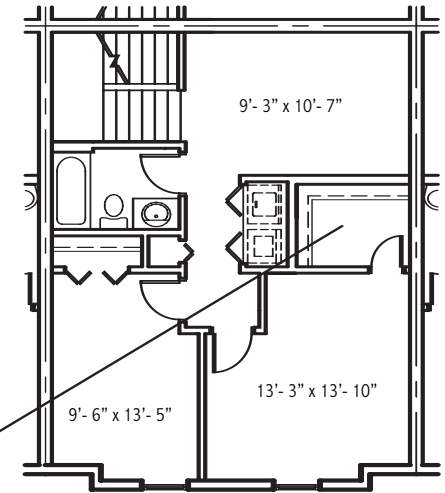

UPPER



# EMERSON

3 BR  
1518 sq ft

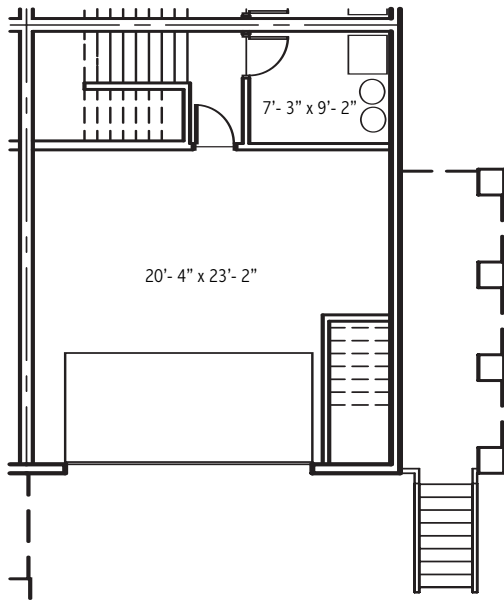
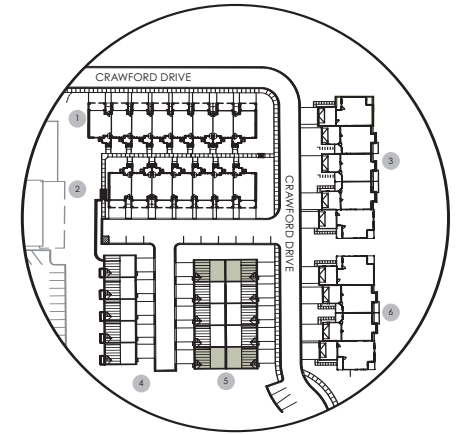

GARAGE

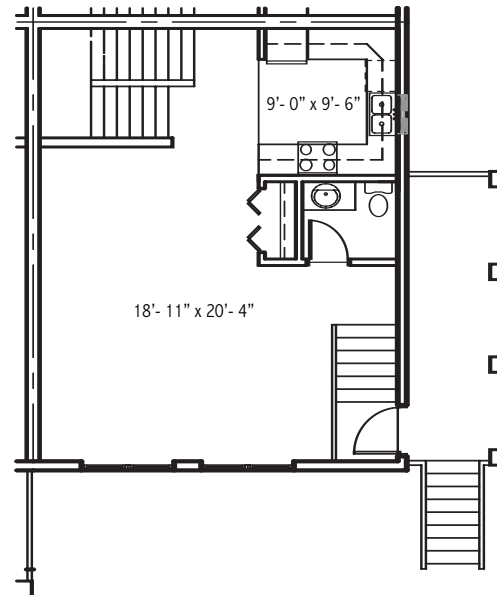

MAIN

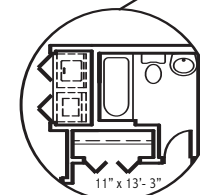

Optional  
Master Bath

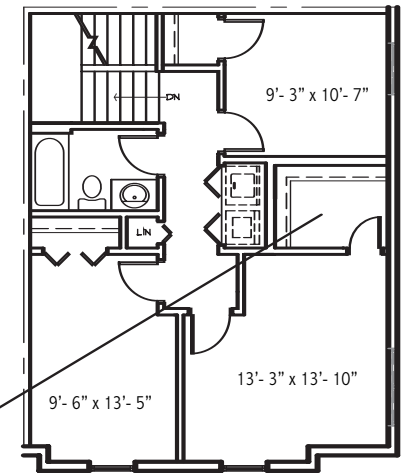

UPPER



# CHARLTON

2 BR  
1411 sq ft

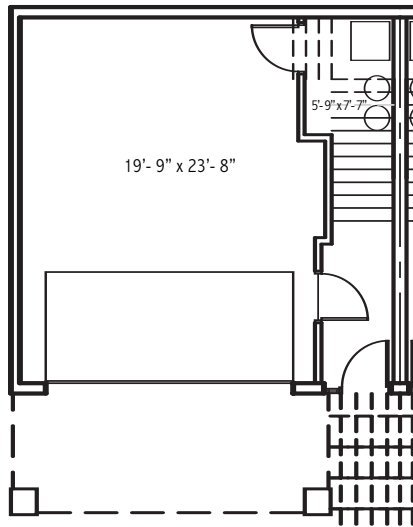
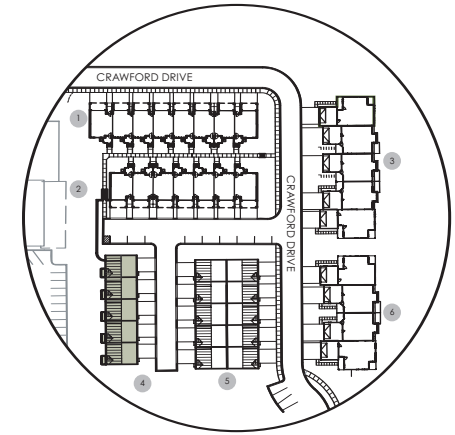

GARAGE

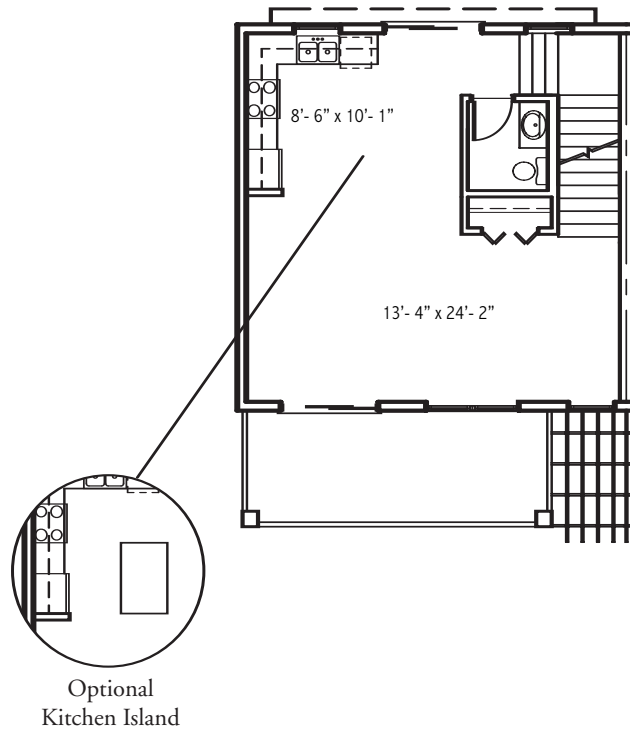

MAIN

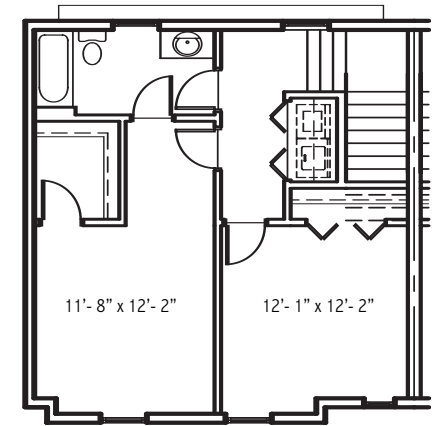

UPPER



# THOMPSON

1 BR + DEN

1236 sq ft

1187 sq ft (Optional Finished Basement)

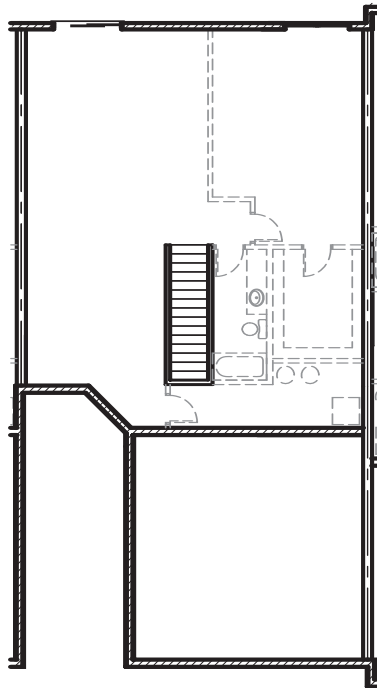
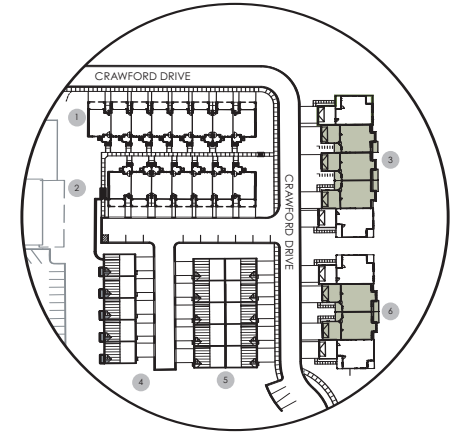
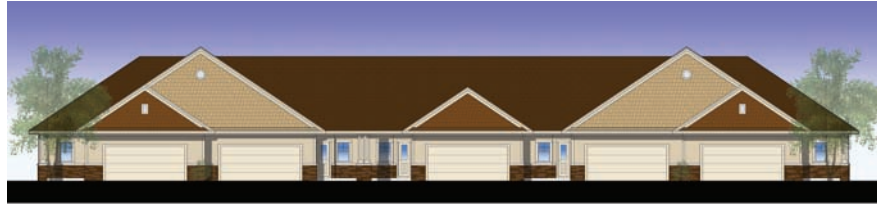

LOWER

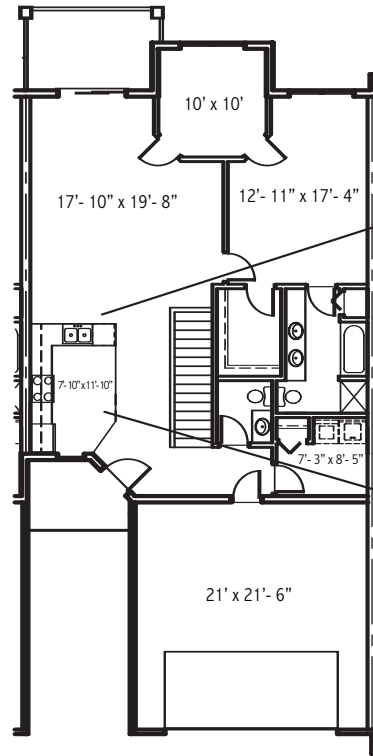

MAIN

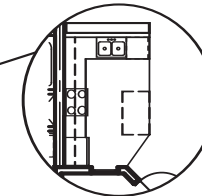

Optional  
Breakfast Bar

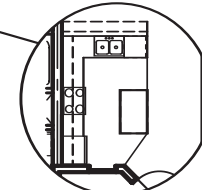

Optional  
Kitchen Island



# THOMPSON

2 BR

1314 sq ft

1314 sq ft (Optional Finished Basement)

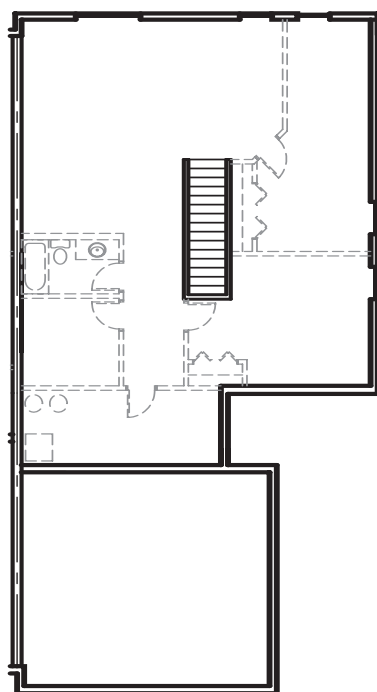
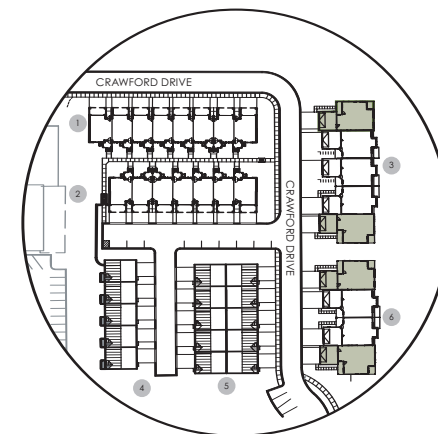

LOWER

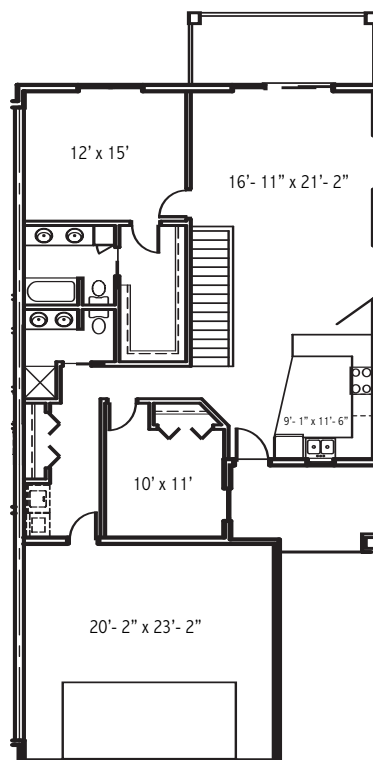

MAIN

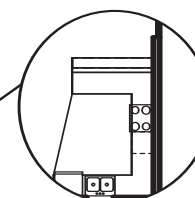

Optional  
Breakfast Bar



# SITE PLAN

